

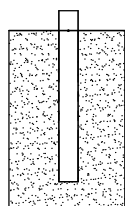

Leikin ja liikunnan edelläkävijä.

## 51-4-8VIII23-1A Jousihirvi asennusohje

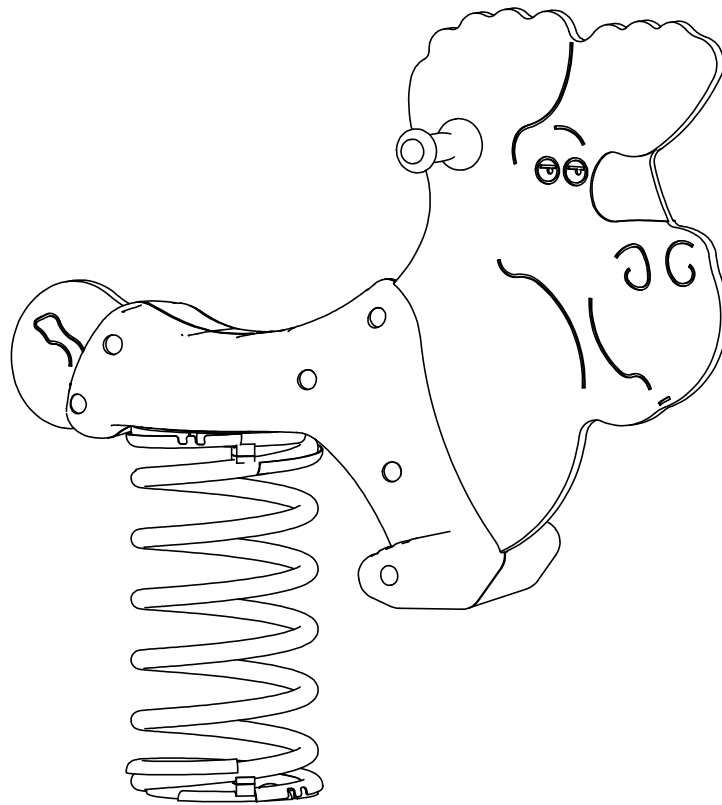

51-4-8VIII23-1A N  
ankkuri

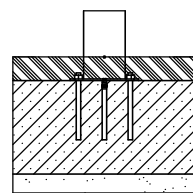

51-4-8VIII23-1A F  
pinta

51-4-8VIII23-1A N

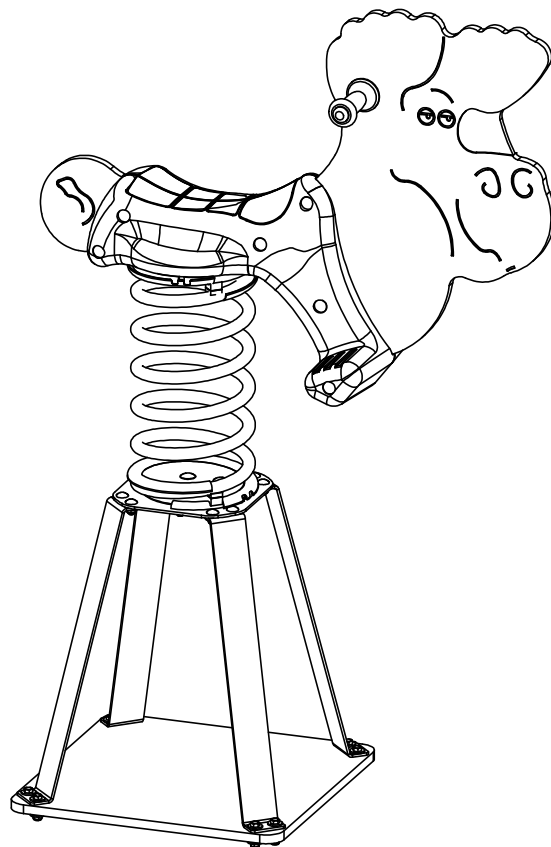

51-4-8VIII23-1A F

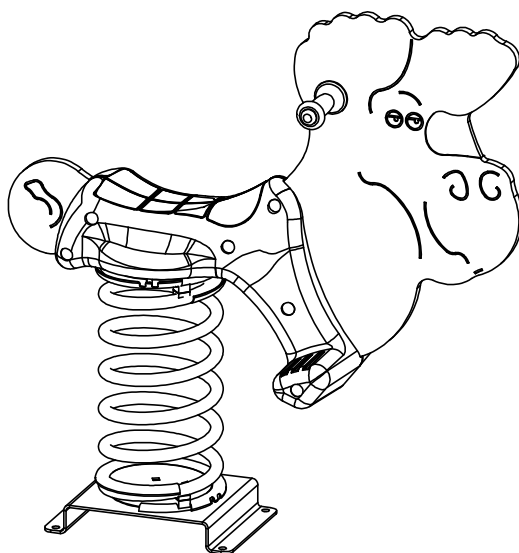

51-4-8VIII23-1A N

51-4-8VIII23-1A F

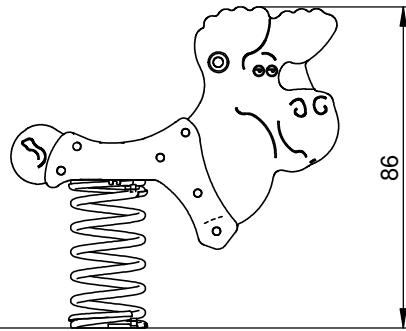

"0"

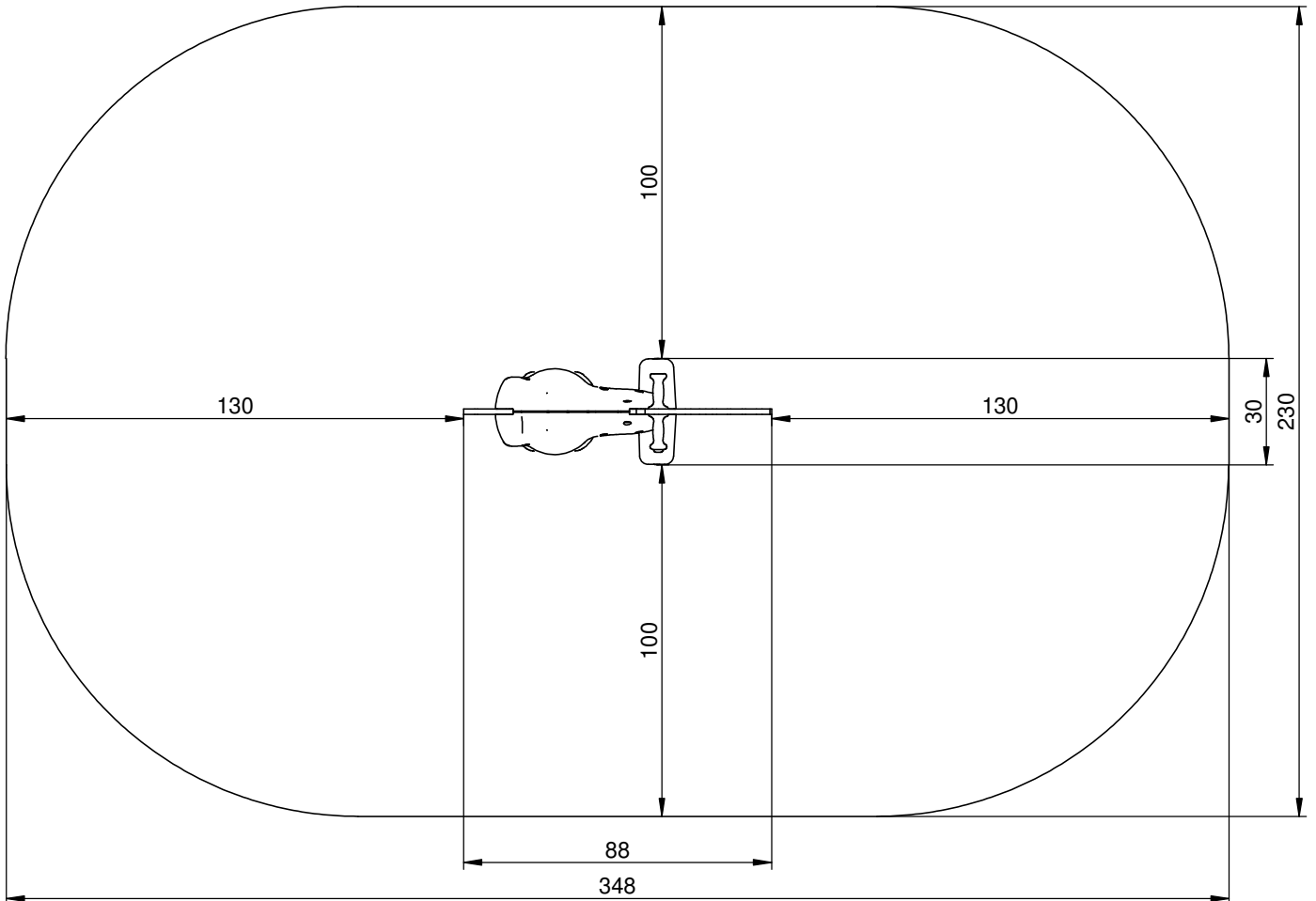

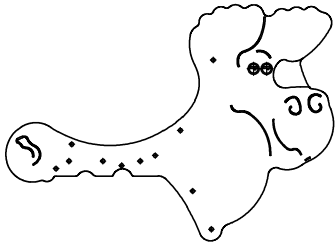
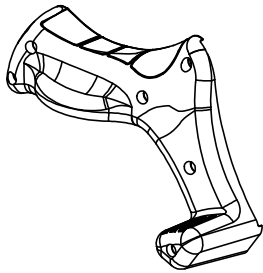
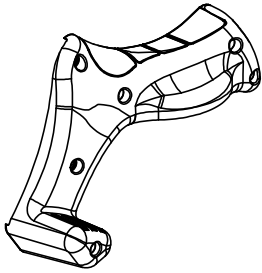
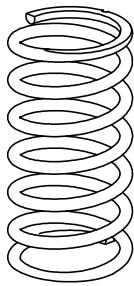
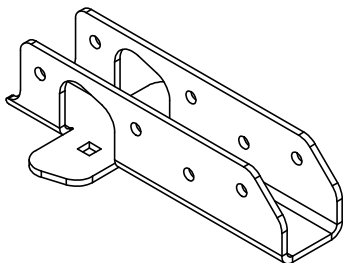
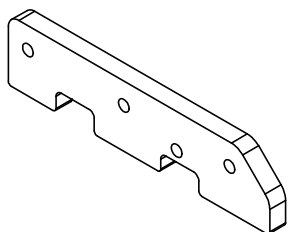
**NR ELEMENT****E1****1****E2****1****E3****1****E4****1****E5****1****E6****2**

NR	ELEMENT	
E7		2
E8		1
E9		4
E10		1

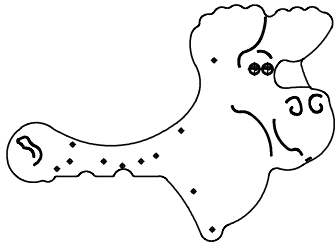
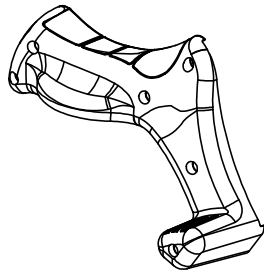
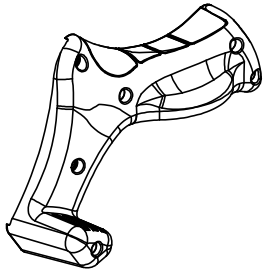
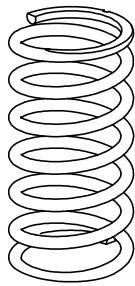
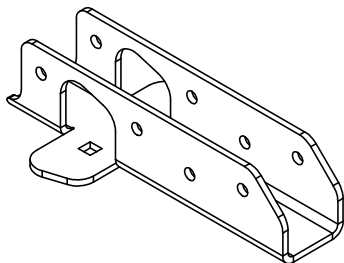
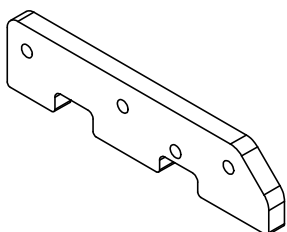
**NR ELEMENT****E1****1****E2****1****E3****1****E4****1****E5****1****E6****2**

**NR ELEMENT**

**E7**

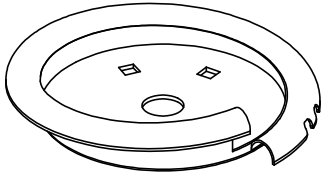

**2**

**E8**

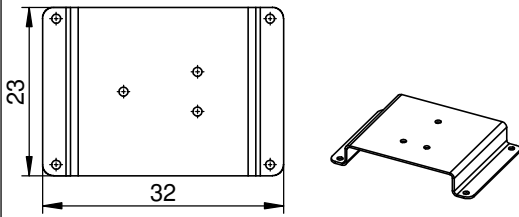

**1**

**E9**

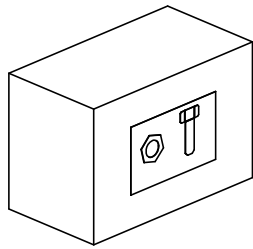

**1**

**1** N, F

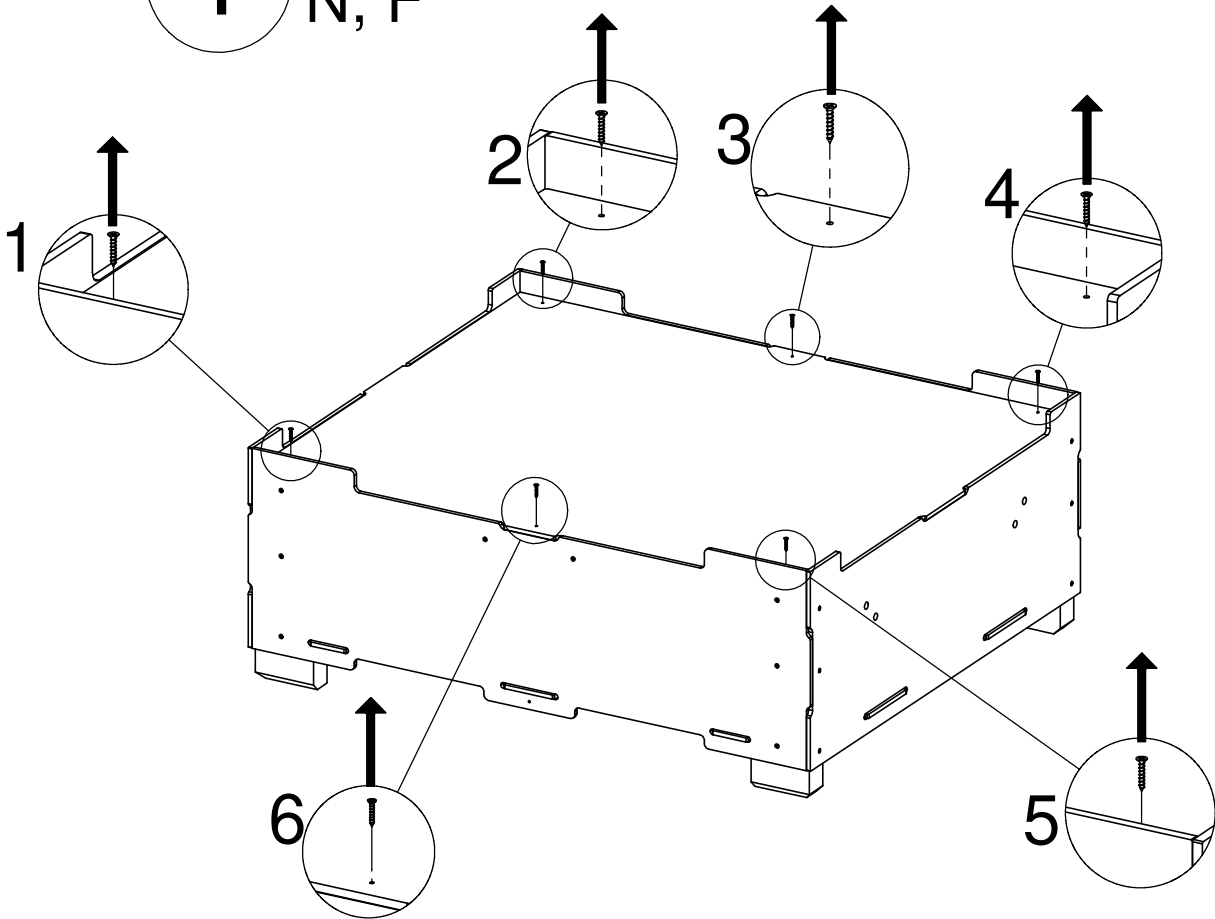

**2** N, F

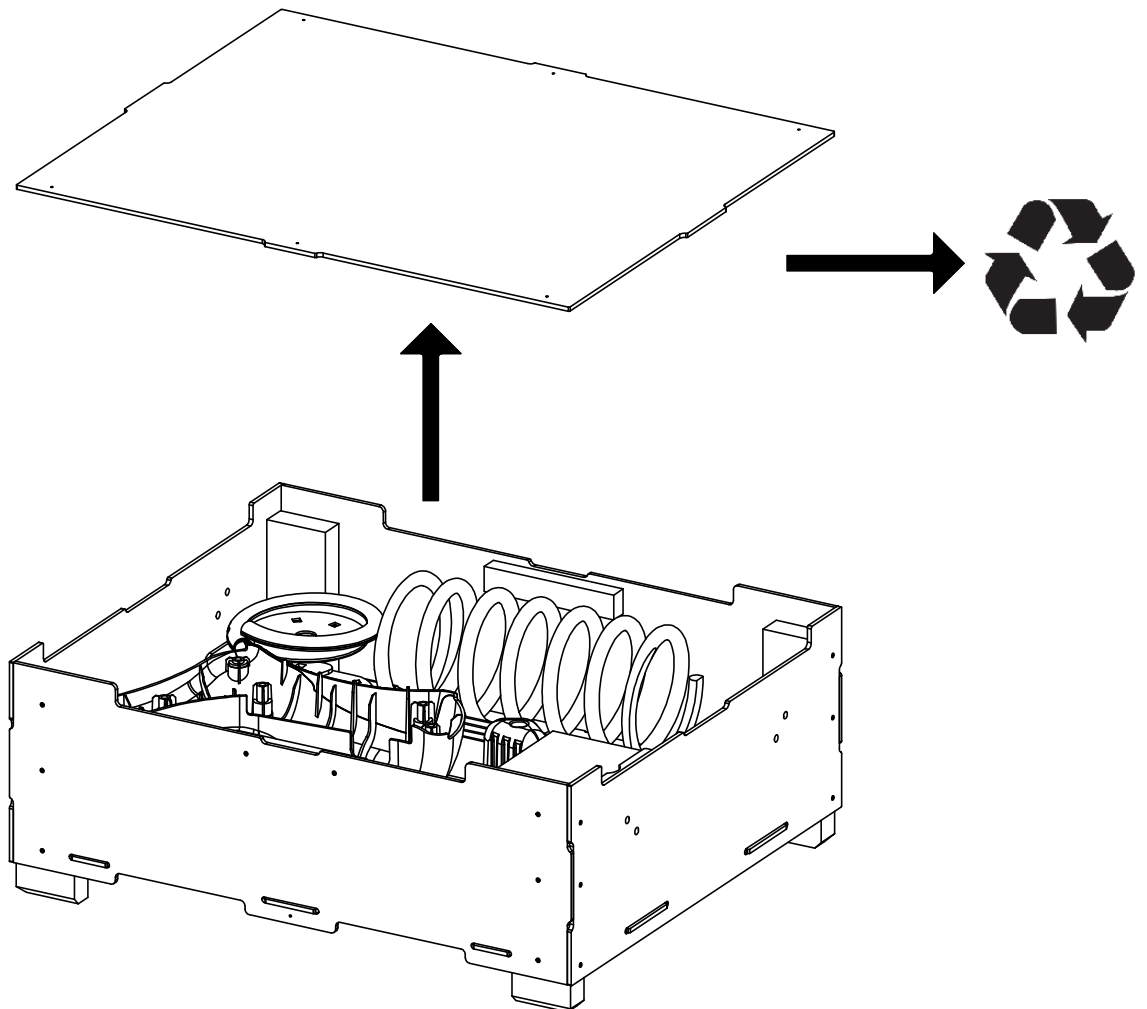

3 N, F

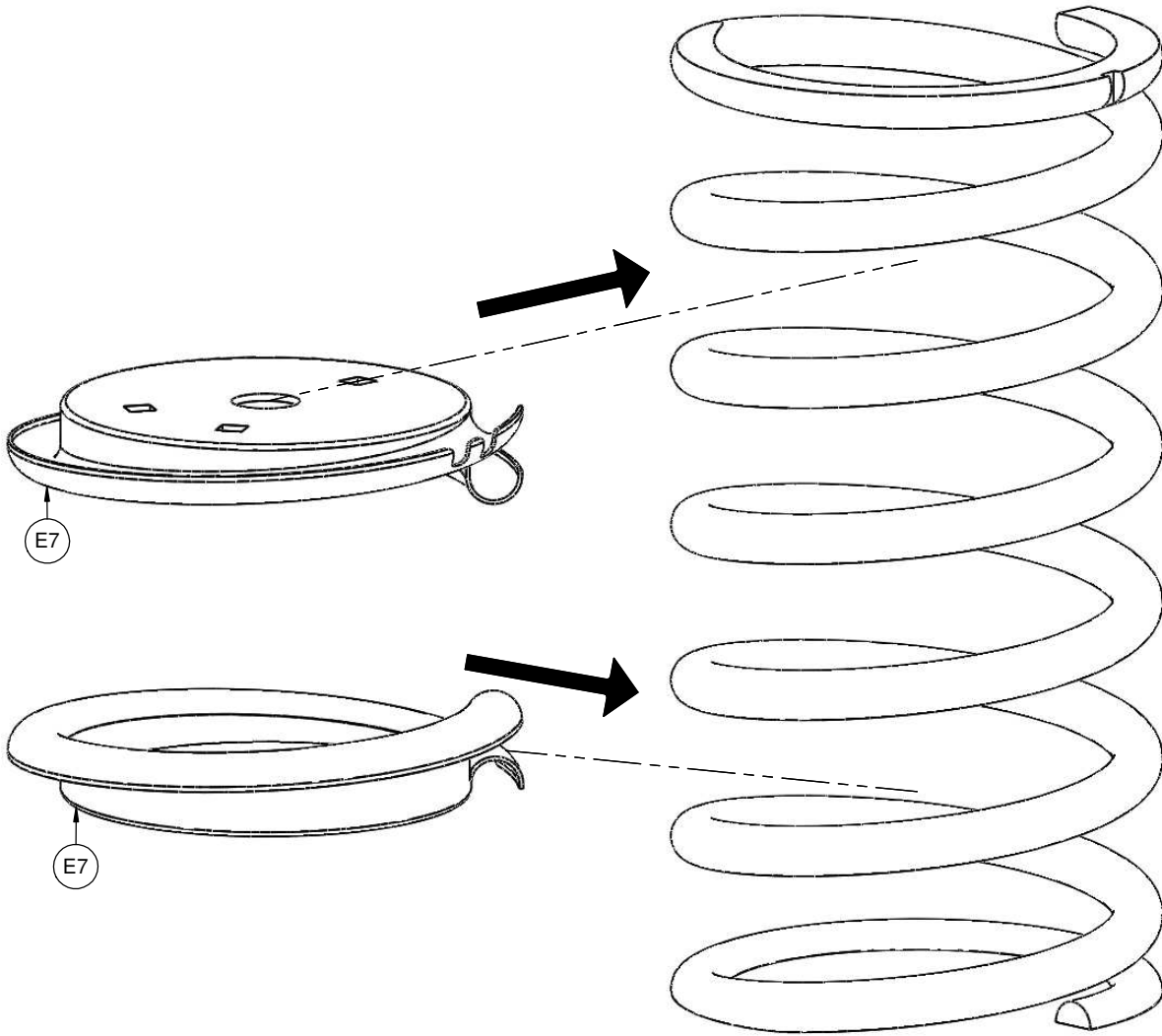

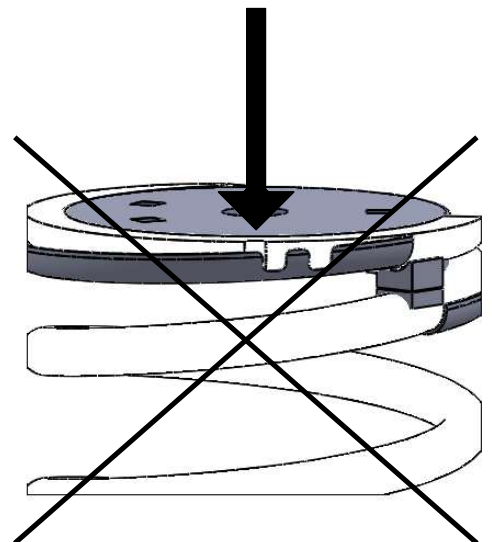
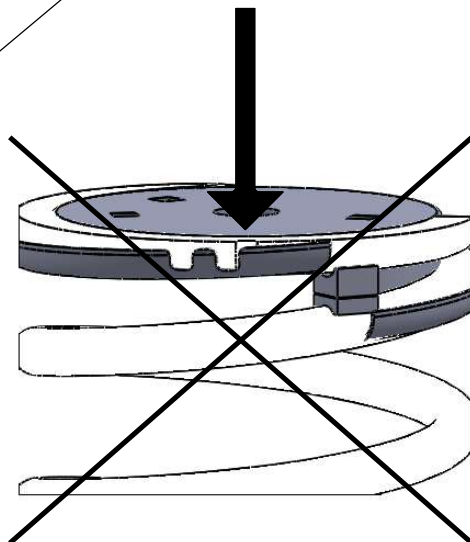
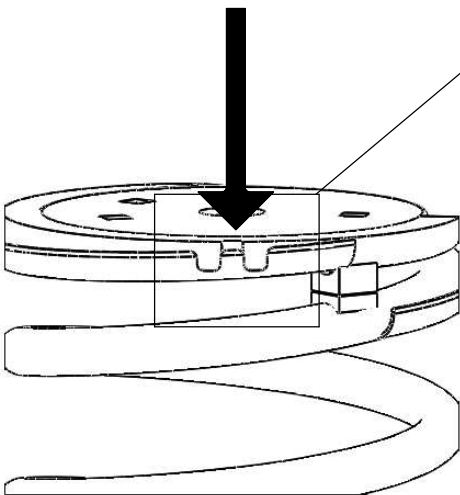
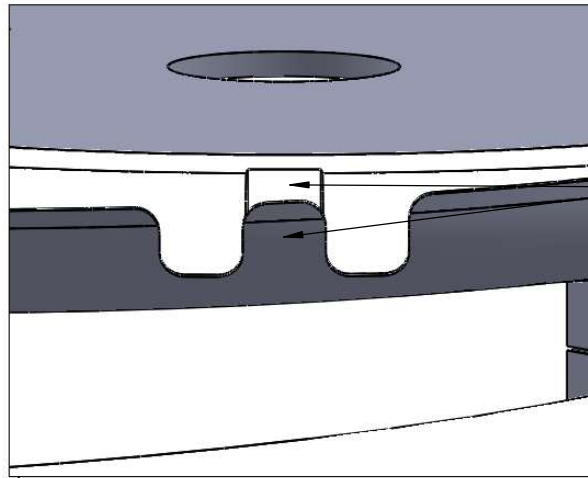
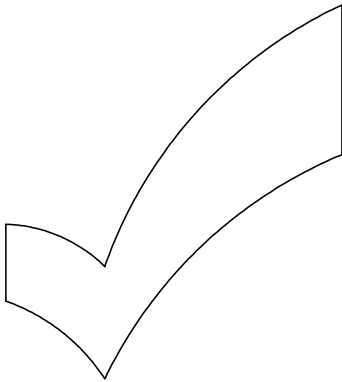
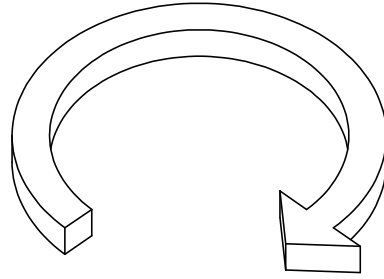
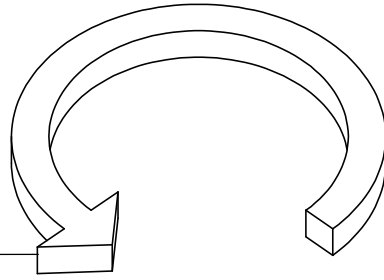
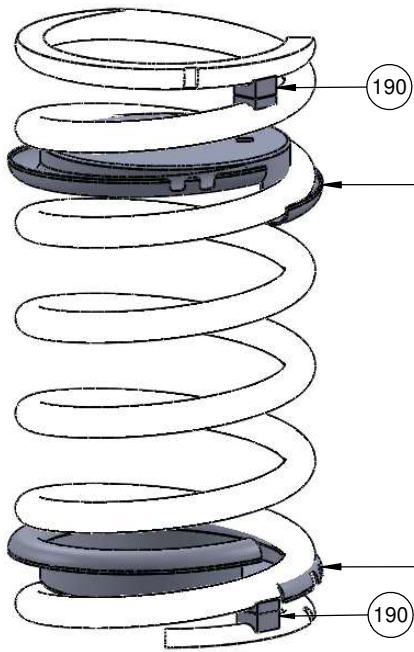

4 N, F

Nr	Element		Σ
190		-	K_B_1
			2



# 5 N, F

Nr	Element			Σ
5		DIN 985	M10 (OC)	3
103		DIN 9021	10x30	3
145		DIN 603	M10x30 (OC)	3

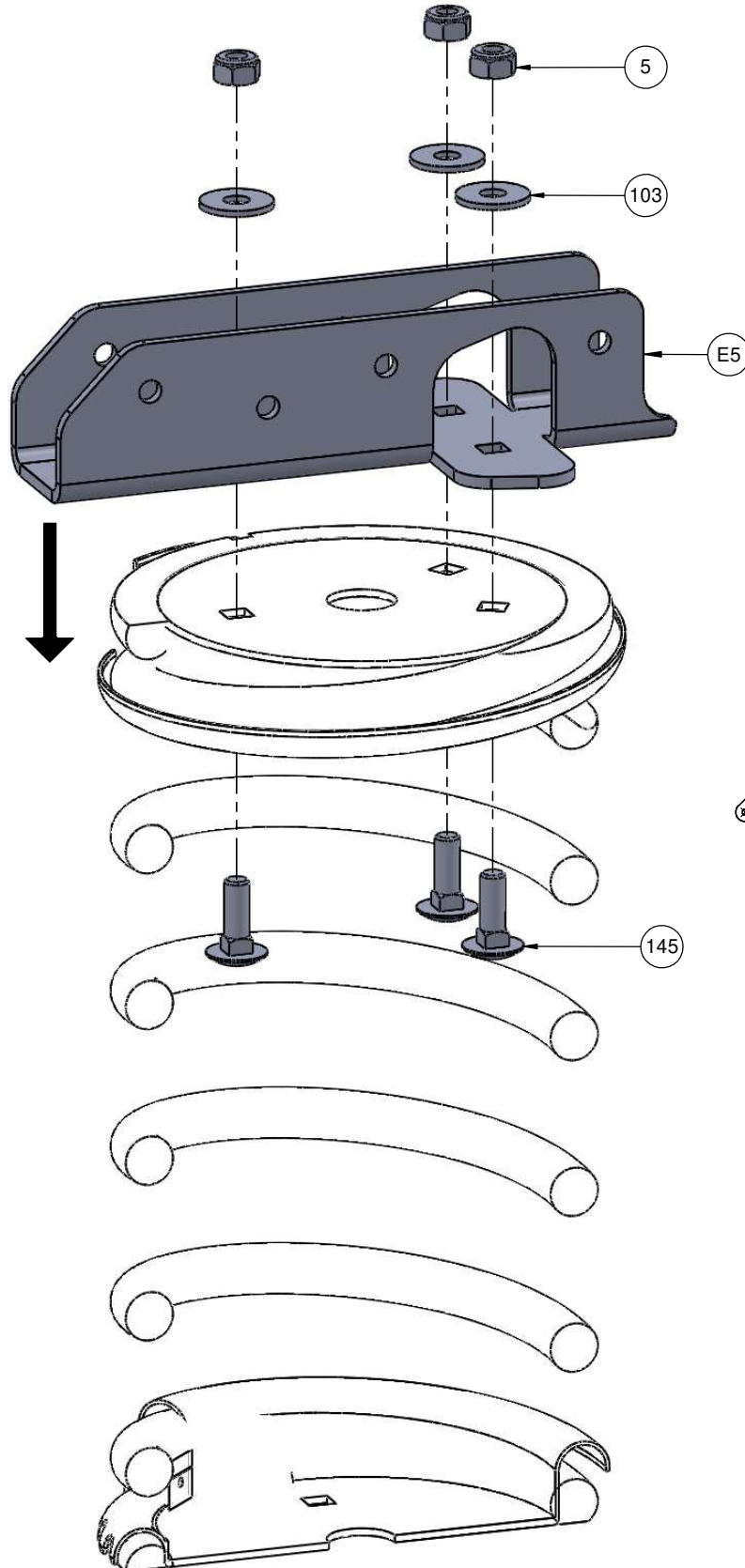

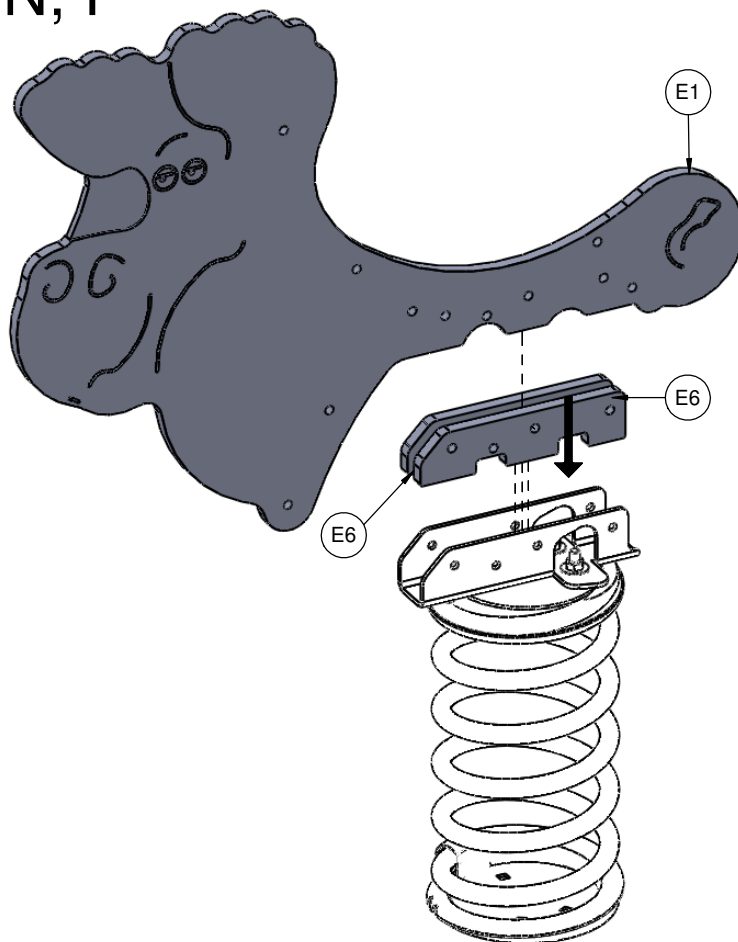

6 N, F

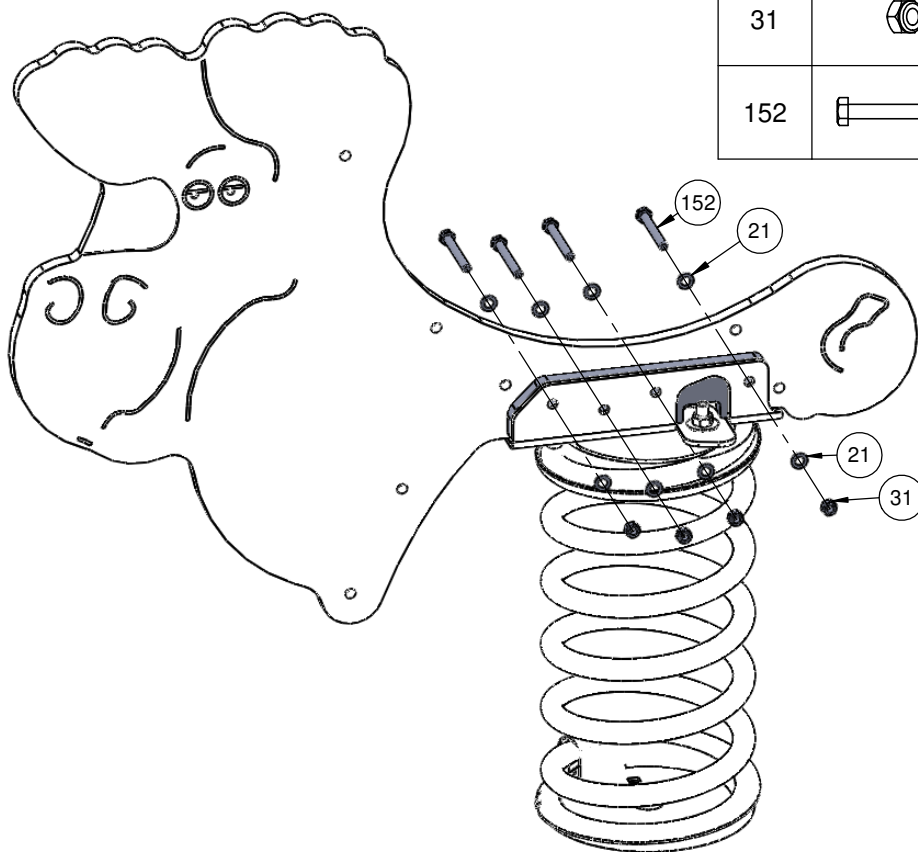

7 N, F

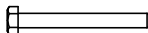

Nr	Element			Σ
21		DIN 125	8x16	8
31		DIN 985	M8 (OC)	4
152		DIN 931	M8x70	4

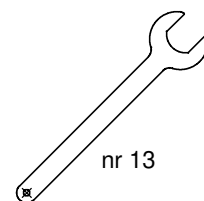

8

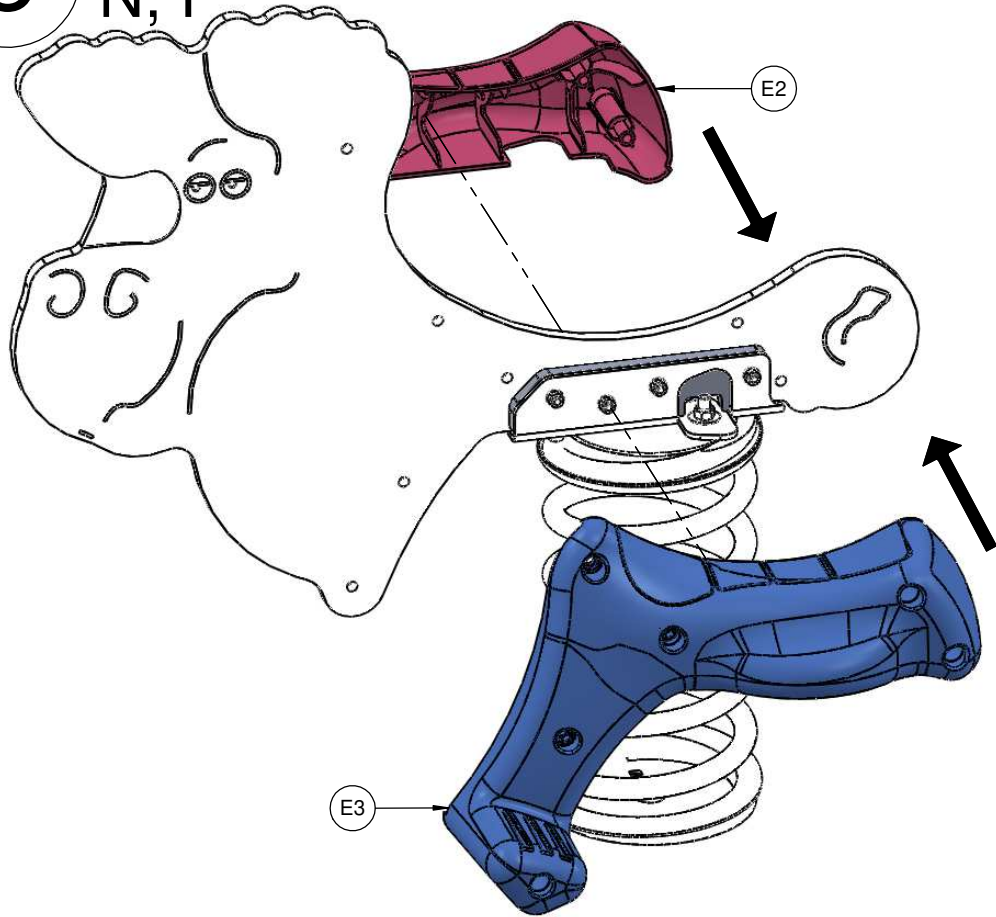

N, F



9

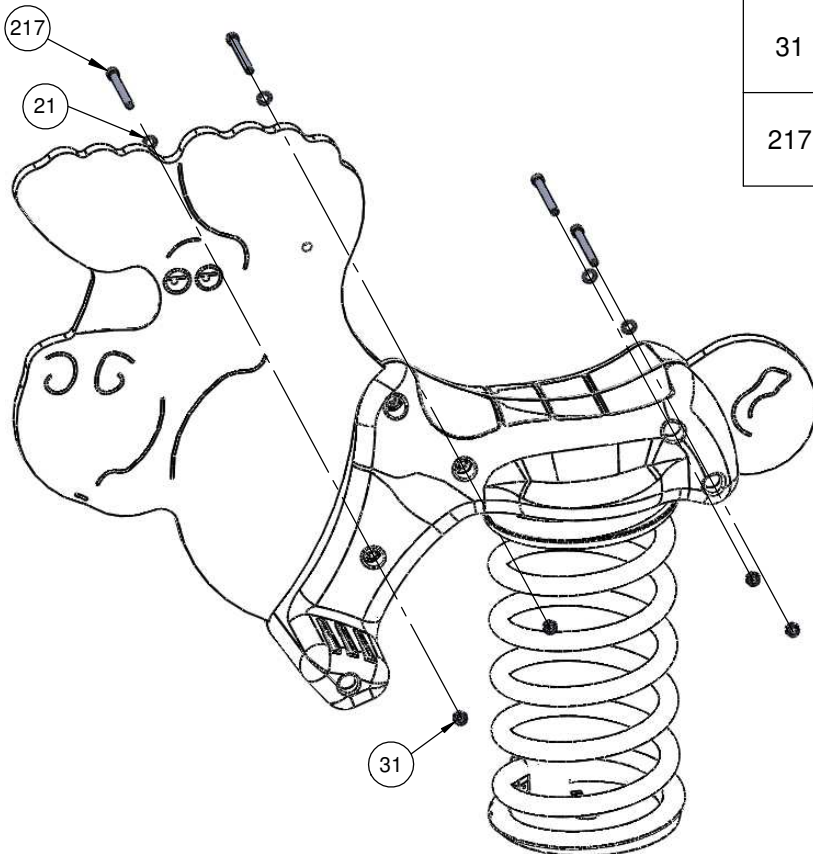

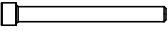

N, F

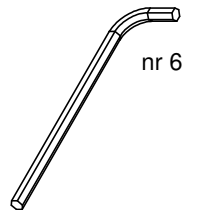

Nr	Element			Σ
21		DIN 125	8x16	4
31		DIN 985	M8 (OC)	4
217		DIN 912	M8x80	4

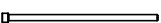

# 10 N, F

Nr	Element			Σ
21		DIN 125	8x16	2
31		DIN 985	M8 (OC)	2
189		DIN 912	M8x200	1
216		DIN 912	M8x40	1

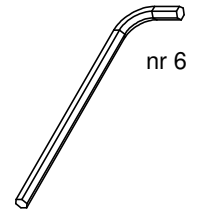
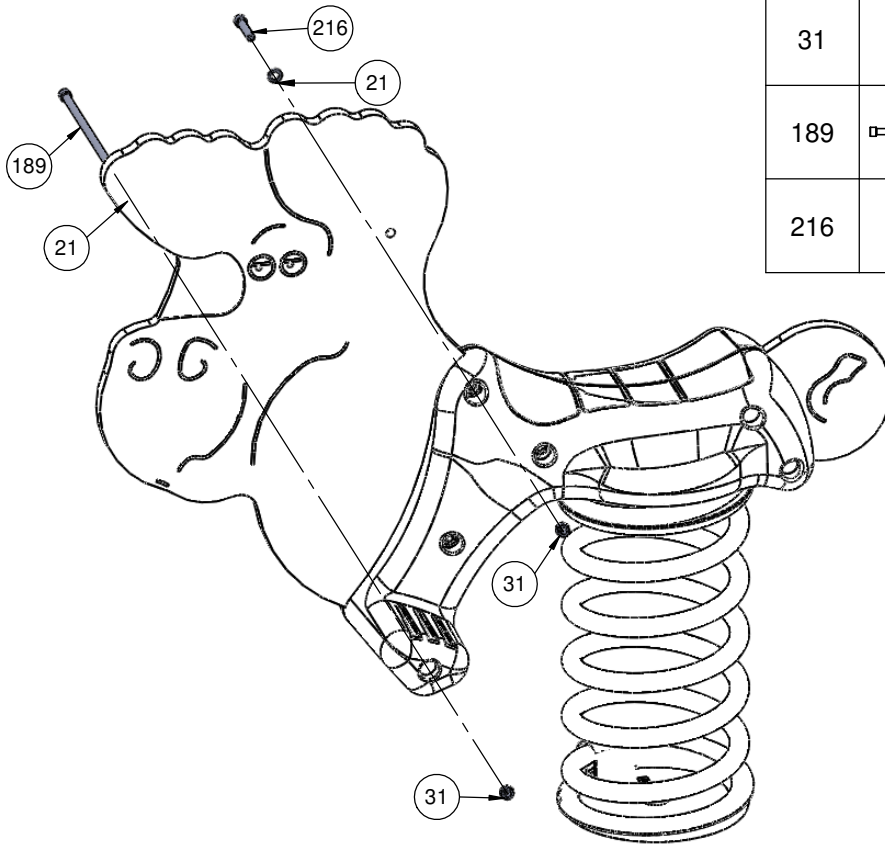





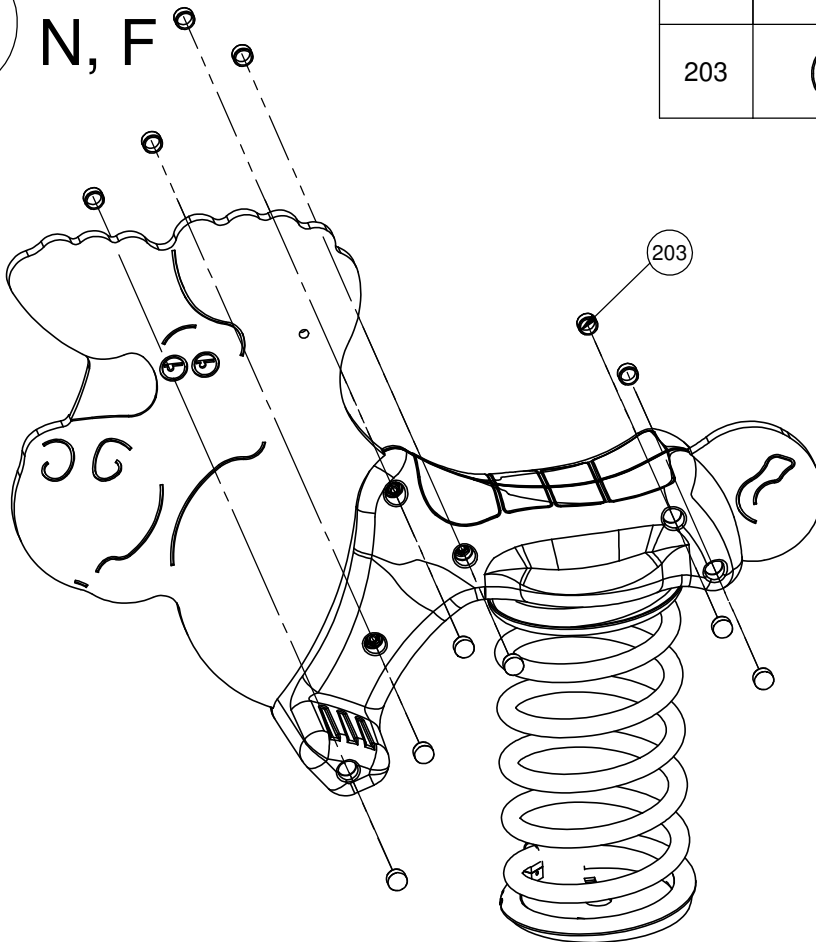

# 11 N, F

Nr	Element			Σ
203		-	Z_B_1_BR	12

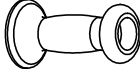

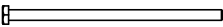

# 12 N, F

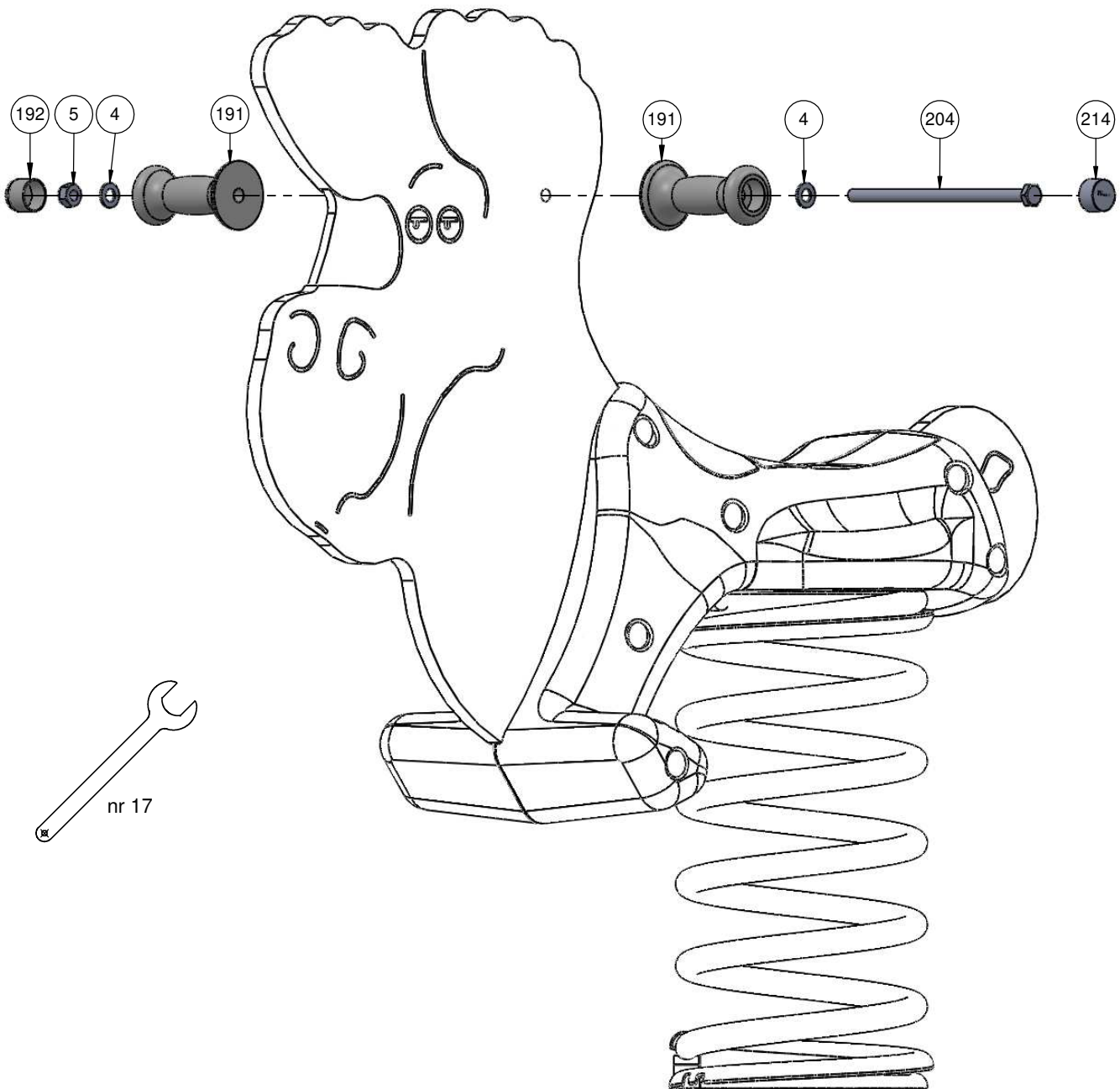
Nr	Element			Σ
4		DIN 125	10x20	2
5		DIN 985	M10 (OC)	1
191		-	R_B_1	2
192		-	R_B_Z_1	1
204		DIN 931	M10x200 (OC)	1
214		-	Z_NA_2	1



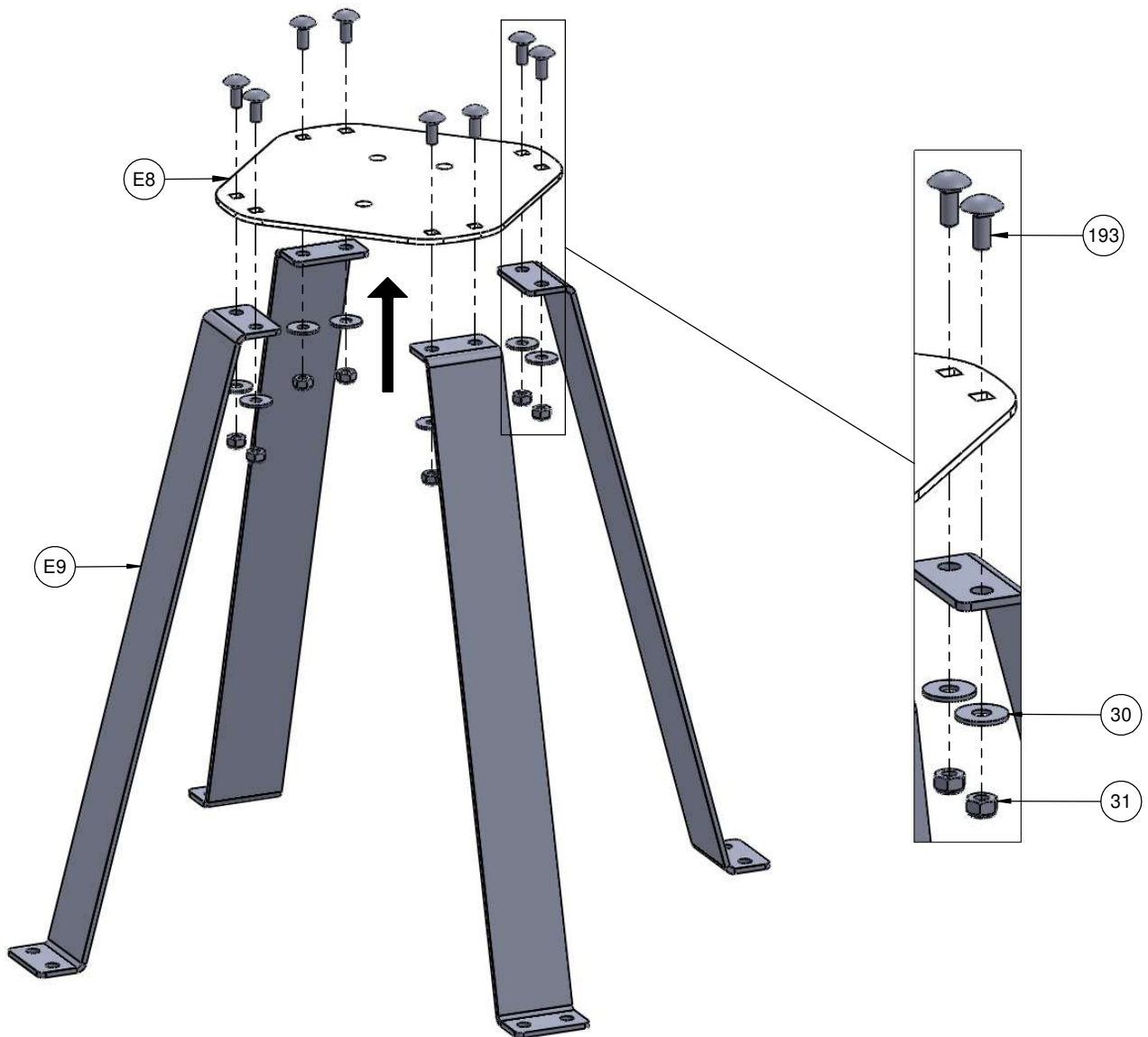
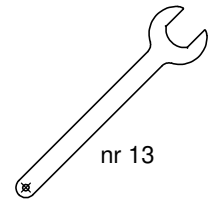

13 N

Nr	Element			Σ
30		DIN 9021	8x24	8
31		DIN 985	M8 (OC)	8
193		DIN 603	M8x20 (OC)	8



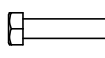

# 13 N

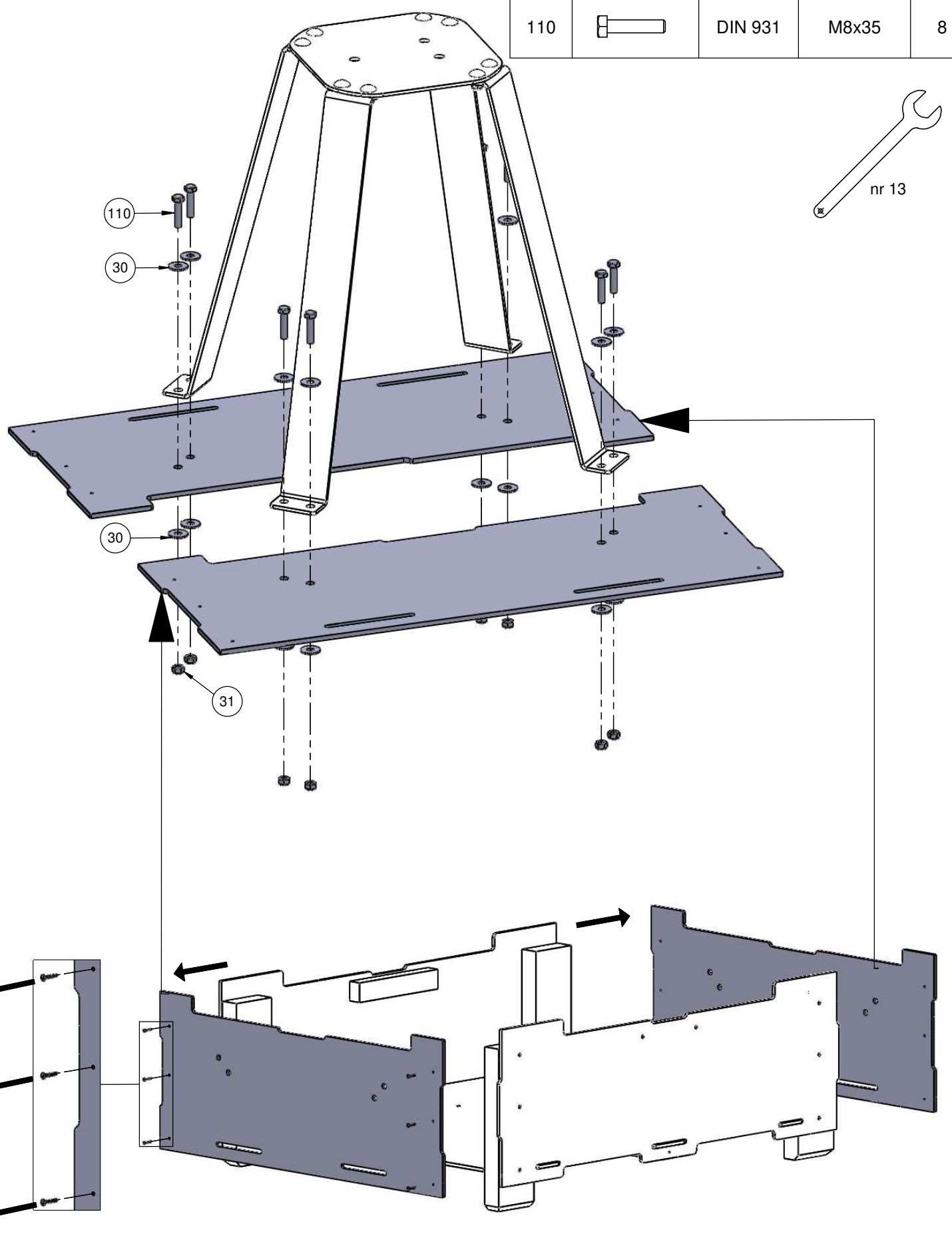
Nr	Element			Σ
30		DIN 9021	8x24	16
31		DIN 985	M8 (OC)	8
110		DIN 931	M8x35	8



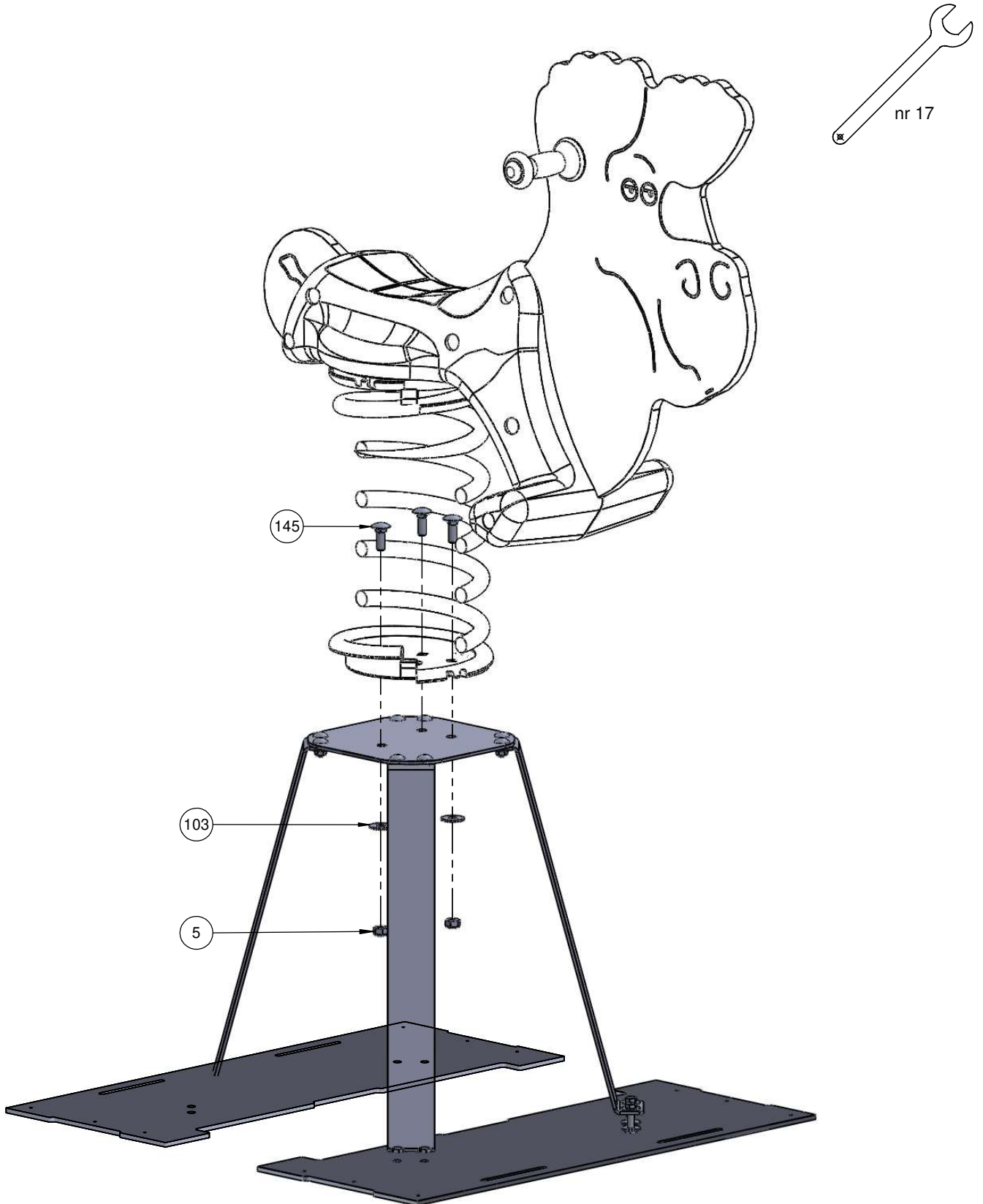

# 13 N

Nr	Element			Σ
5		DIN 985	M10 (OC)	3
103		DIN 9021	10x30	3
145		DIN 603	M10x30 (OC)	3



13

F

Nr	Element			Σ
5		DIN 985	M10 (OC)	3
103		DIN 9021	10x30	3
145		DIN 603	M10x30 (OC)	3

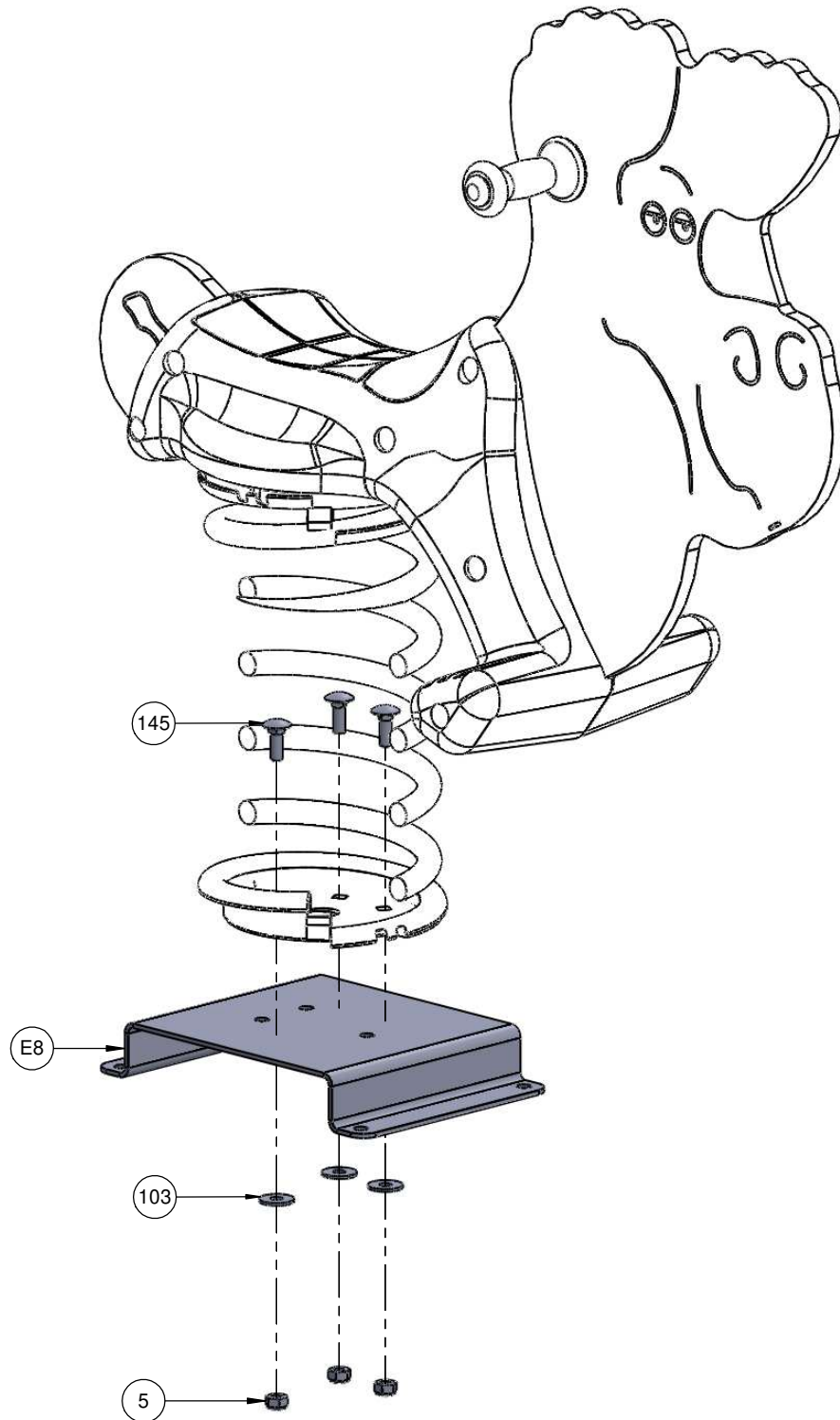

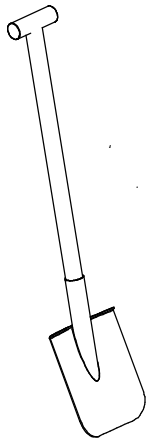

14 N

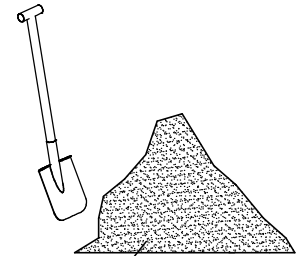
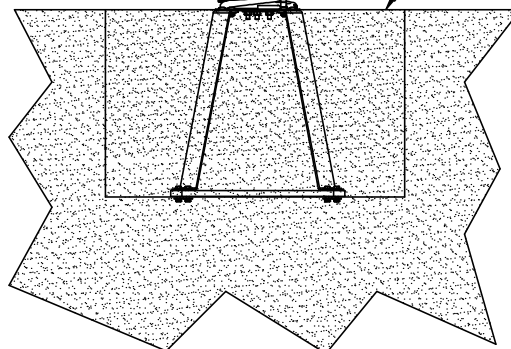
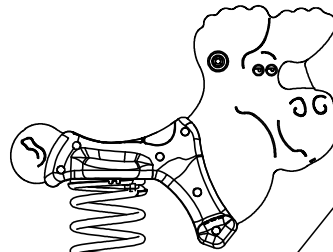
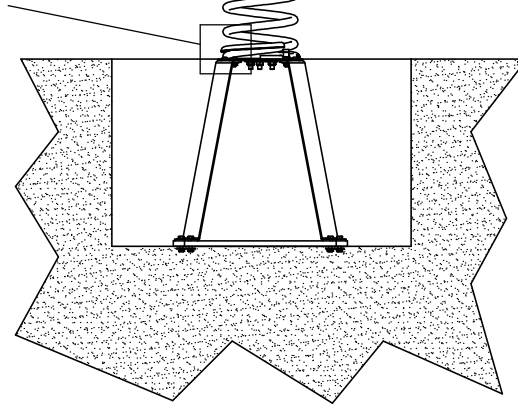
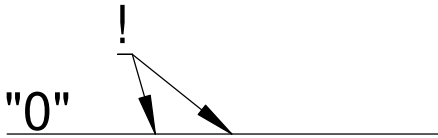
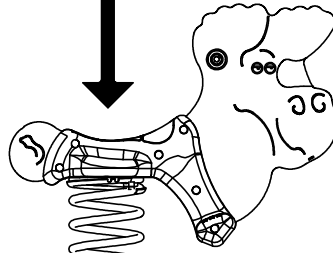
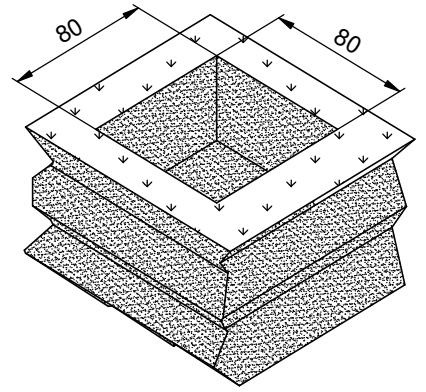
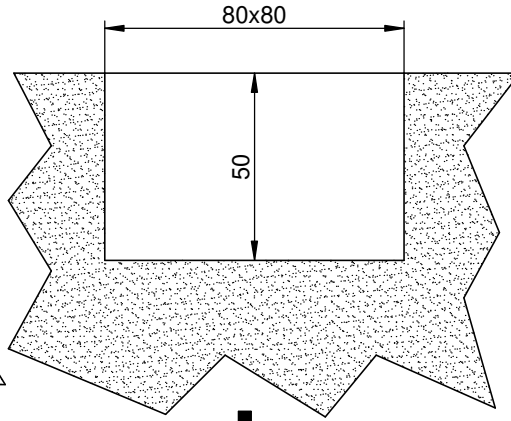
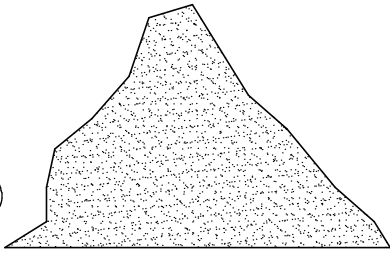

# 14 F

Nr	Element		Σ
61		-	KL105 (OC) 4

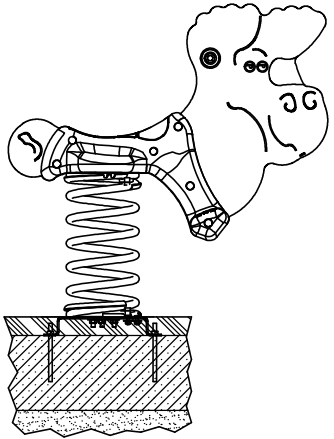

I

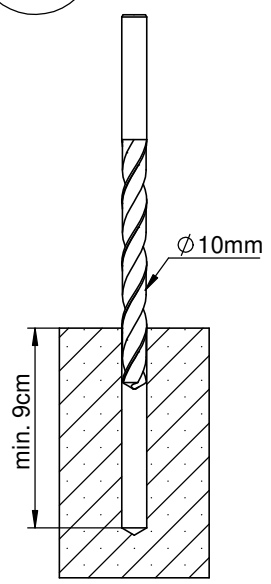

II

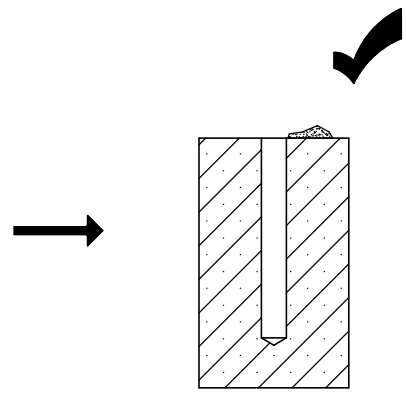
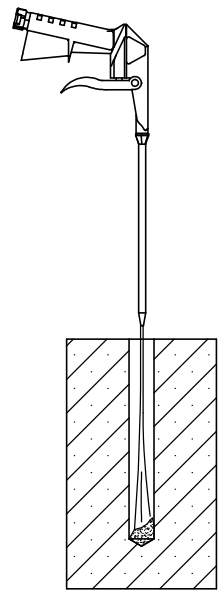

III

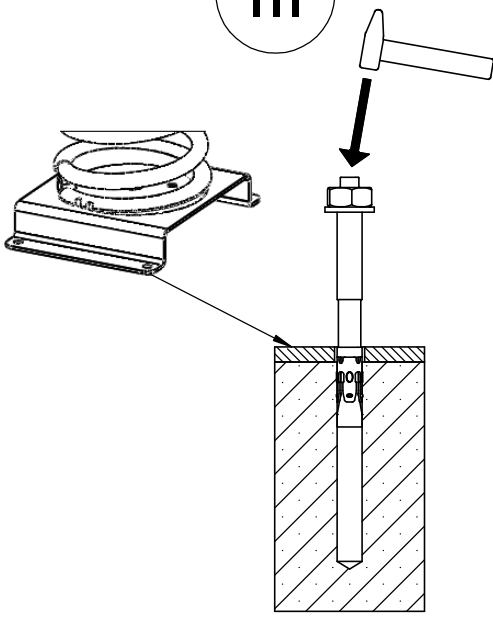

IV

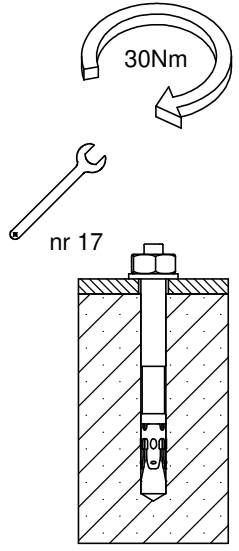

V

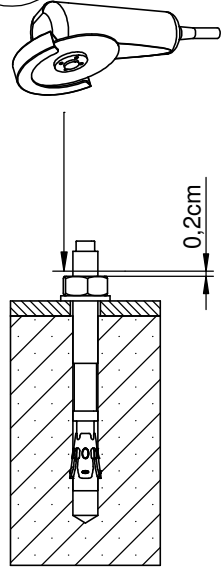

VI

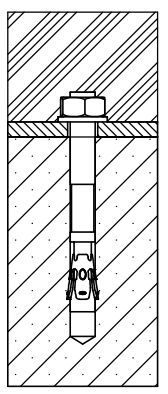

# Tuotteen huolto-ohje

Leikkikenttävälineemme täyttävät EN-1176-1 : 2017- 12 -standardin turvallisuusvaatimukset.

On suotavaa ottaa yhteyttä tuotteen valmistajaan liittyen takuun alla olevien osien huoltotöihin. Vahingoittuneet maalipinnat tulee puhdistaa pölystä, rasvasta ja ruosteesta. Tämän jälkeen puhdistettu pinta tulee peittää ruostumattomalla pohjamaalilla ja sitten maalata kahdesti teräspinnoille tarkoitetulla maalilla.

LeikkiSet Oy:n käyttämät väriyhdistelmät:

- 1) Harmaa - RAL 7035
- 2) Keltainen - RAL 1003
- 3) Sininen - RAL 5015
- 4) Punainen - RAL 3000
- 5) Vihreä - RAL 6018
- 6) Musta - RAL 9005
- 7) Violetti - RAL 4008
- 8) Antrasiitti - RAL 7016
- 9) Hopea - RAL 9006
- 10) Beige - RAL 1019
- 11) Oranssi - RAL 2009

Puu vaatii säännöllistä huolenpitoa. Ilmasto-olosuhteista, käyttöasteesta ja mekaanisista vaurioista riippuen on suositeltavaa uudistaa kyllästyskerros 2 - 5 vuoden kuluttua.

Suosittellemme käyttämään tuotteita: GORI 356 puunsuoja-ainetta ja NORDICA EKO 3330-12-BASE T pintamaalia (väri 1806), nämä löydät sivustolta [www.teknos.com](http://www.teknos.com).

Suosittelavaa on, että osat jotka ovat ruostumatonta terästä puhdistetaan kerran vuodessa, jotta epäpuhtaudet eivät aiheuta värimuutoksia teräkseen. Pese puuvillaliinoilla ja veteen liuotetulla miedolla pesuaineella, esim. astianpesuaine. Puhdistuksen jälkeen huuhtelee vedellä ja pyyhi kuivaksi.

**HUOMIO!** Ruostumattoman teräksen puhdistukseen käytettävät puhdistusaineet eivät saa sisältää: klooria, suolaa, happoja tai valkaisuaineita. Jo pieni määrä näitä aineita voi aiheuttaa kromioksidipinnan pysyviä vaurioita

- 1) Kausittainen tarkastus - kun väline on aktiivisessa käytössä, tulee sen kunto tarkastaa viikoittain tai useammin. Samalla tulee tarkistaa mahdolliset välineeseen kohdistuneet ilkeivät teot.

Kausittainen tarkastus pitää sisällään:

- Rakenteiden vakauden tarkistaminen
- Yleinen tarkastus osien puuttumisen varalta
- Tarkistaminen halkeamien, terävien reunojen ja muiden vaurioiden varalta
- Välineen ympäristön siisteys
- Mahdollisen turva-alustan kunnon tarkistaminen

- 2) Välineen sisäinen valvonta - tulee suorittaa kerran kolmessa kuukaudessa. Se pitää sisällään yleistarkastuksen, minkä lisäksi tulee tarkistaa myös välineen toiminnot.

Sisäinen valvonta pitää sisällään:

- Mahdollisen turva-alueen pinnan tarkistaminen ja mittaaminen (jos pinta on yli 10cm alle oikean tason, pitää sitä täydentää)
- Kaikki ruuvit ja mahdolliset kaapelit sekä verkot tulee kiristää

### 3) Vuositarkastus (pakollinen)

- Rakenteiden vakauden tarkistaminen
- Mahdollisten ruostevaurioiden tarkastaminen ja korjaaminen
- Perustusten tarkistaminen
- Mahdollisen turva-alueen pinnan tarkistaminen ja mittaaminen (Jos pinta on yli 10cm alle oikean tason, pitää sitä täydentää)

Kaikilla laitteilla on oltava säännöllinen tarkastusvalvonta. Tarkastuksen tekijän tulee kirjata tiedot tarkastuksesta ylös.